

Instruction and Descriptive List of Parts

The MERROW

PLAIN CROCHET

BLANKET HEMMING and EDGING

and

SHELL STITCH MACHINES

THE MERROW MACHINE COMPANY

28 LAUREL STREET HARTFORD, CONNECTICUT 06106 U.S.A.

INSTRUCTIONS

FOR SETTING UP AND OPERATING AND DESCRIPTIVE LIST OF PARTS FOR PLAIN CROCHET BLANKET HEMMING AND EDGING AND SHELL STITCH MACHINES

This book contains instructions for setting up and operating Merrow High Speed Plain Crochet, Blanket Hemming, and Edging on Shell Stitch Machines, together with illustrations of the representative parts and a descriptive list of the commonly used parts.

All moving parts subject to friction and wear have been carefully designed and accurately formed to give the maximum utility, durability, and interchangeability for continuous and perfect operation at high speed.

In addition to the machines described in this booklet, we also make Merrow Class MG and Class M Overstitching Machines and Class 70 Butted Seaming Machines. These machines have been long and favorably known and used by manufacturers throughout the world.

Over a period of years, numerous parts for our Machines have been designed for special uses and since their application is limited, these parts are not listed herein. It is anticipated that new parts will be developed in the future as style and fashion change. Your individual problems will receive our prompt attention.

HOW TO ORDER

We keep a record of each part model contained in the various machines as they leave our factory, and can supply duplicates if given the NAME of the part with STYLE and SERIAL number of Machine.

If difficulty is experienced in selecting which of the many parts is the one needed, give the NAME of the part indicated in Descriptive List with STYLE and SERIAL number of Machine for which such part is desired, and we expect to be able to make proper selection.

When ordering Needle Plates and Needle Guards, state the size of Needle used.

Letters or numbers are stamped on most of the parts when ordering duplicates, give the NAME of part and the LETTERS or NUMBERS stamped thereon. The stamping on a particular part is insufficient information without giving the NAME of the part. The PART NUMBER is stamped on the shank near the butt end of all crochet hooks.

THE MERROW MACHINE COMPANY

28 LAUREL STREET, HARTFORD, CONNECTICUT, 06106 USA

Established 1838

Incorporated 1894

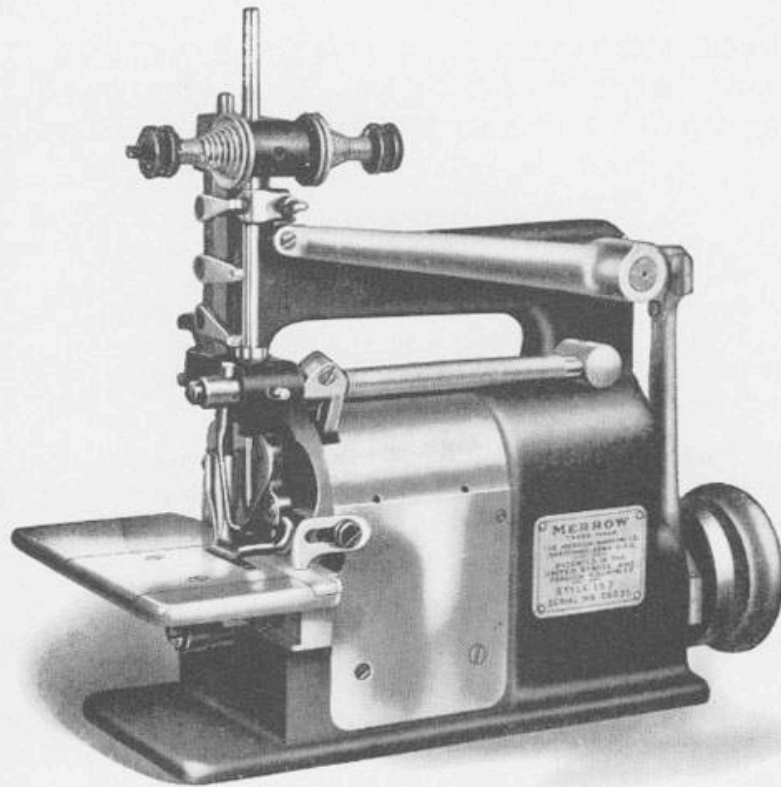

PLAIN CROCHET MACHINES

These machines are regularly made in several styles for different widths of finish, embodying different devices adapted for finishing raw or cut edges of a great variety of knit and woven fabrics, thoroughly covering all loose ends and projecting threads, and forming an ornamental border. The finish may be made very elastic or quite firm, and two threads of different colors, materials or sizes, may be employed to produce a great range of effects.

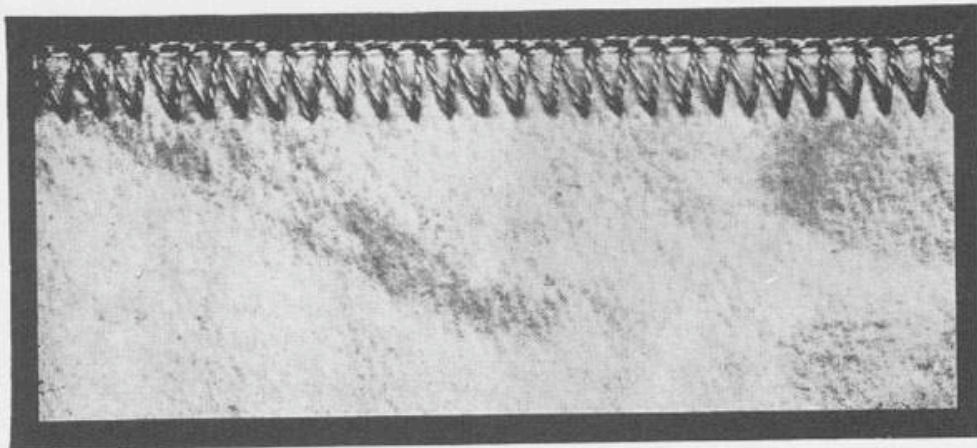

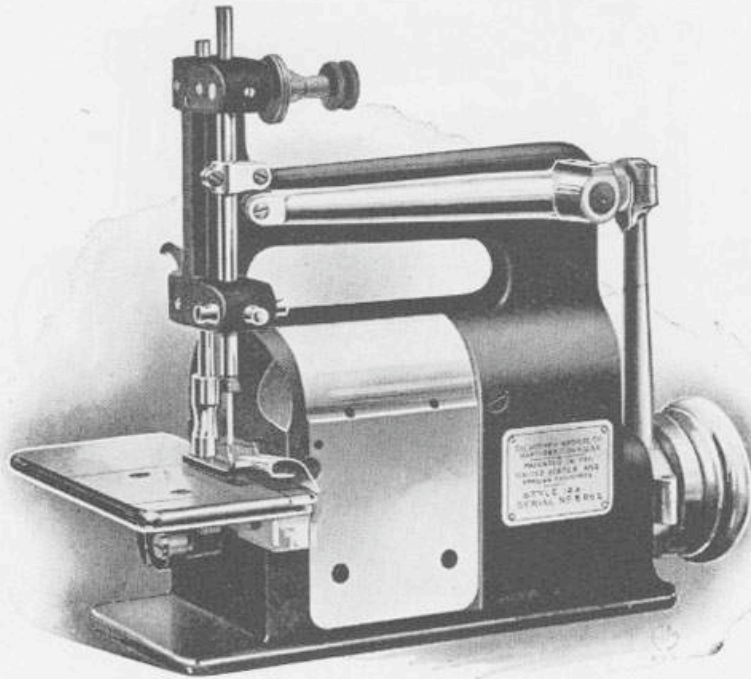

BLANKET HEMMING AND EDGING MACHINES

The single thread finish produced by these machines is known as the Blanket Stitch, and is well suited for finishing the edges of very thick articles like felt pads and felt boot tops, or for hemming the edges of horse blankets and other heavy fabrics. When used on fabric of medium weight, the edge may be turned under the hem, thus forming a double fold. These machines may be arranged to make either a medium or wide hem as ordered.

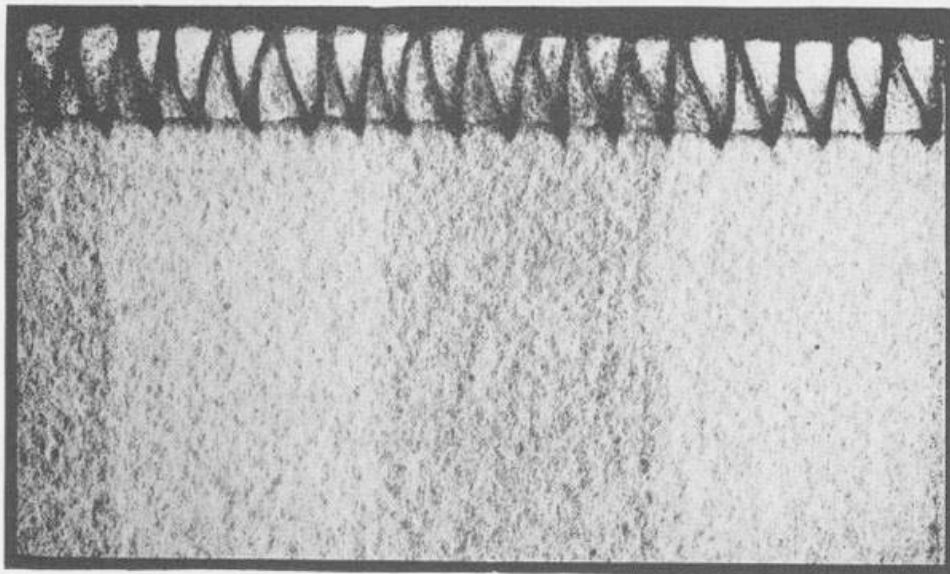

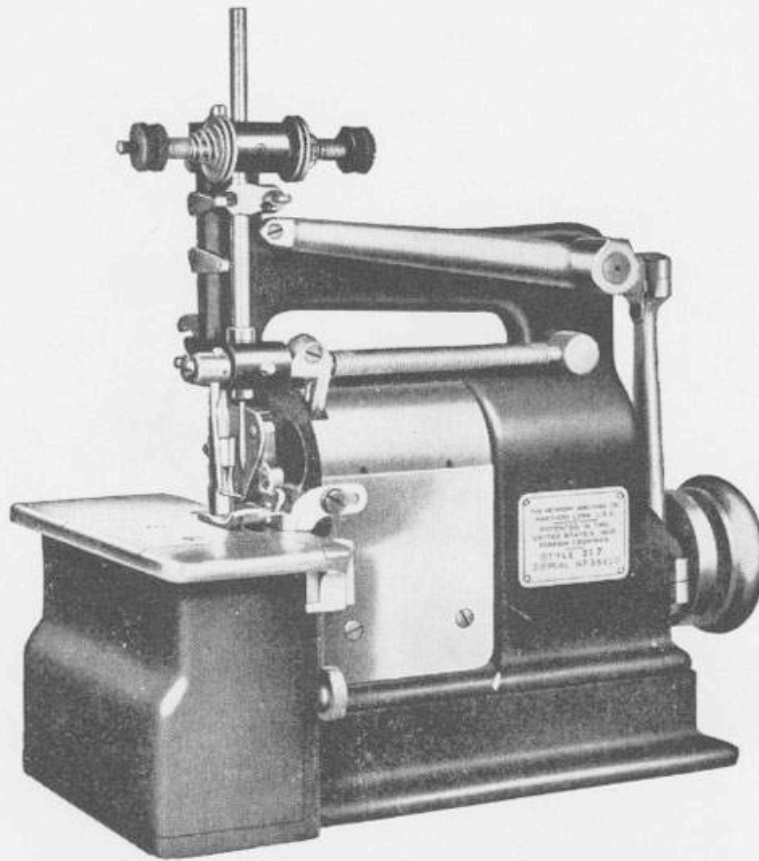

SHELL STITCH MACHINES

These machines produce our two thread crochet stitch in clusters, giving a shell-like effect, closely resembling hand work. The finish is extremely attractive and substantial, and is suitable for ornamenting the edges of a great variety of articles of utility and apparel.

Quite a range in the size of the shells is obtainable in the different styles of machines, and by the use of a variety of colors and sizes of thread or yarn, the results are pleasing.

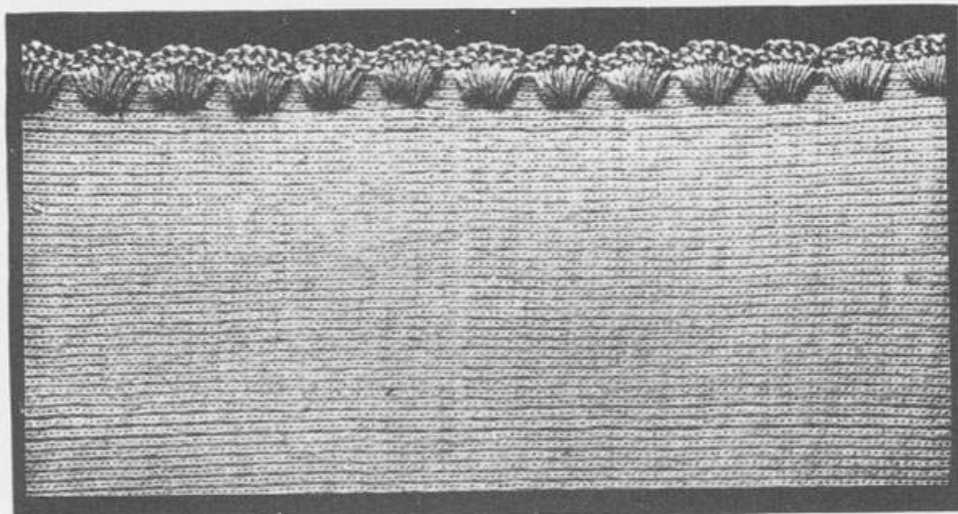

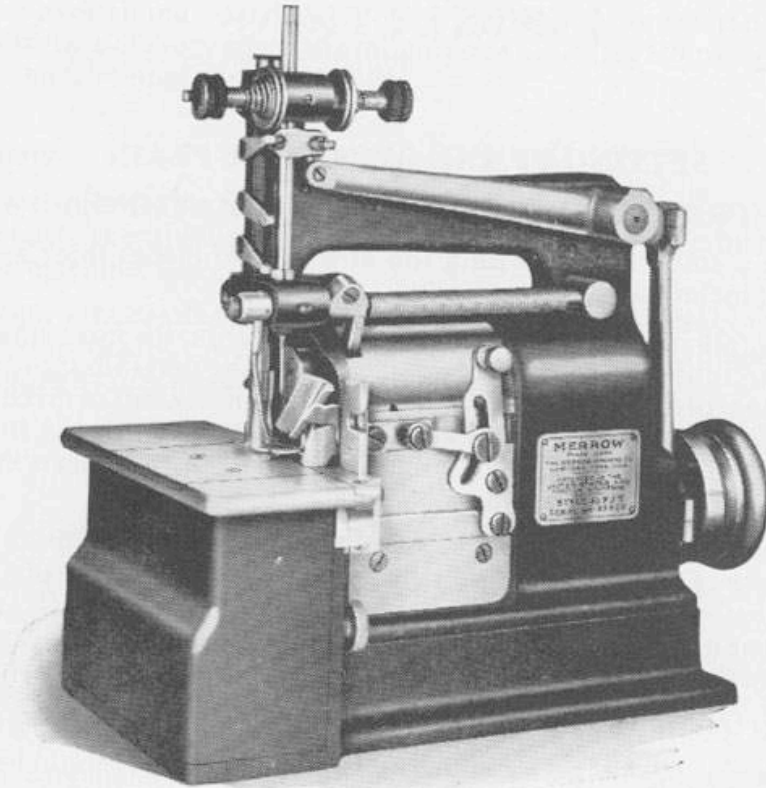

SHELL STITCH MACHINES

3 stitch and 6 stitch shells
4 stitch and 8 stitch shells
Plain crochet stitch and 6 stitch shells
Plain crochet stitch and 8 stitch shells
Taping

The machines are made in various specific styles for producing shell stitch edge finish of different sizes, and to produce any one of the two different combinations of finishes noted above, with devices for changing the style of the stitch from one to the other, while the machine is in operation or at rest, and at the same time automatically adjust the position of the fabric edge guide.

A presser foot lifting apparatus, controlled by the foot of the operator, guides and tension for feeding tape or ribbon under the finish, are included in some of the styles.

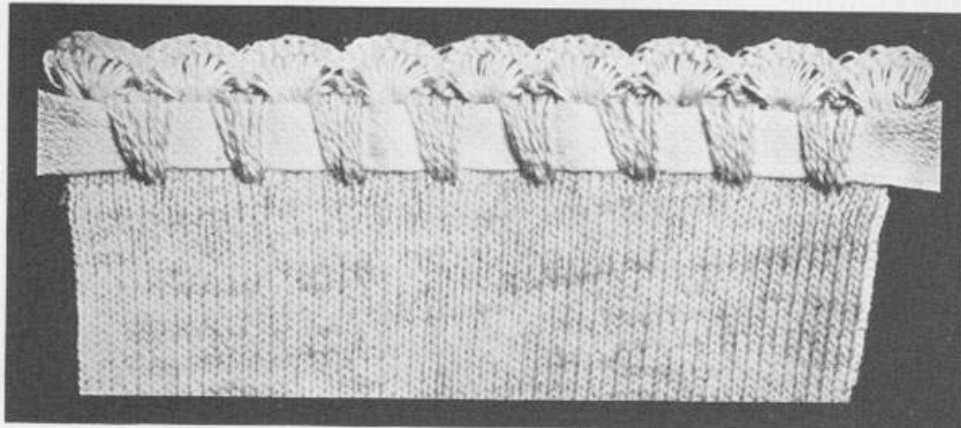

INSTRUCTIONS

SETTING UP AND OPERATING PLAIN CROCHET AND SHELL STITCH MACHINES

1. Provide a smooth table with a top at least two inches thick and about twenty-eight inches high.
2. Immediately after removing the machine from its box, observe the threading carefully, and compare it with the threading diagram shown on page 19. The manner of threading is not exactly the same in all kinds of machines, and a diagram showing the threading is sent with each machine, but for general purposes, cuts included in this book may be referred to in connection with the printed description of the threading.
3. Secure the machine to the table with the felt pad sent with the machine under the base of the machine, using the screws also sent with the machine, the hand wheel being placed at the right hand of the operator, and the front or base of the machine parallel with the front edge of the table, and with the center of the main shaft of the machine about five inches back from the front of the table.
4. A power transmitter should be used for starting and stopping the machine.
5. When laying out the transmission equipment, attempt should be made to avoid driving from a large pulley to a relatively smaller pulley, the centers of which are close together, as such an arrangement will allow excessive slippage of the belts, materially reducing the speed of the start and stop of the Merrow Machine.
6. A Hand Wheel with an effective (pitch) diameter of $3 \frac{7}{32}$ " is supplied with each machine. If an individual transmitter is used, the machine may be run with a $\frac{3}{8}$ " endless V-Belt. For group drive where round belting is used, either $\frac{1}{4}$ " or $\frac{5}{16}$ " round belting may be used.
7. Avoid crossed belts where possible.
8. The top of the Hand Wheel of the Merrow Machine must turn away from the operator.

Speed to Run Machines

9. Style 18 Single Thread Blanket Hemming and Edging Machines should be run from 1000 to 1200 stitches per minute.

Styles 15 and 24 Two Thread Plain Crochet Machines should be run from 1200 to 1600 stitches per minute.

Style 17 Two Thread Plain Crochet Machines should be run from 1000 to 1500 stitches per minute.

Styles 22, 27, and 35 Shell Stitch Machines and modifications thereof should be run from 1200 to 1500 stitches per minute.

Lubrication

10. Keep the machine clean. Oil frequently, at least four times a day. These machines are necessarily fitted very closely in order to attain their high speed and great durability, and therefore they need frequent oiling, especially when new.

Before re-assembling a machine after having removed any of its parts, be sure that every surface of every part is thoroughly clean and free from all grit and lint, and that each frictional surface is oiled.

Thread Stand

11. Screw the thread stand to the table top back of the machine, with the left end of the base far enough to the right to be clear of the goods which pass back beyond the machine.

The thread, yarn or silk should be wound on cones or conical bobbins which should stand vertically, the thread leading up to the top of the thread stand and thence diagonally downward to the machine.

Never run the thread, yarn or silk from a two-headed spool, or cylindrical tubes.

The Eye Pointed Needle

12. The needles are numbered 2,3,4,5,6,8,10, and 11, No 2 being the finest and but little used, and No. 11 being the largest and adapted to carry the heaviest yarn suitable for any of the machines.

Never use a needle too large for the hole in the needle plate, or for the groove in the needle guard.

Set the needle in the needle bar as far as possible, with the long groove of the needle nearly in front, and fasten it by tightening the nut at the lower end of the needle bar. Make all adjustments of the needle by loosening the clamp screw in the needle bar block.

The needle should be adjusted vertically so the hook (latch needle) will cross the eye pointed needle just above the niche at the upper end of the eye, when the hook is about to grasp the thread or yarn below the fabric. Some variation is admissible, usually more latitude being desirable when using heavy yarn or thread.

The edge of the slatted portion of the needle should be turned slightly away from the point of the hook, as the latter when moving from left to right, crosses the needle below the fabric, so that the point of the hook cannot catch the needle.

Needle Guard

13. The needle guard should be adjusted with its rear end about flush with the rear side of the needle. Its office is to guard the needle from being caught by the hook, but if the end of the needle guard is set too far beyond the needle, the hook will be deflected too much from its course and fail to catch the thread from the needle, besides being injured.

Needle guards in some machines are made with a groove for the needle, and are then provided with a latch opener. The edge of the latch opener should be kept rather sharp and smooth, but not a cutting edge.

These needle guards are made with grooves to fit the needle. Do not use a needle too large for the groove in the needle guard.

Some needle guard ends are detachable from the shank or holder, and this end section only need generally be renewed when worn.

The Hook

(LATCH NEEDLE)

14. The hook should be set into its carrier, projecting to the extent approximately indicated by the HOOK GAUGE sent with the machine. Different conditions require some variation in the distance the hook should project, and when the exact distance is found which best suits the conditions, the HOOK GAUGE should be changed if necessary to correspond.

In any case the hook must project from its carrier far enough, so that when it is at its extreme left hand position below the work, the sharp point of the hook will be at least about 1/32 inch to the left of the needle, so that it will surely grasp the thread from the side of the needle just above the niche at the top of the eye, while the hook travels toward the right.

The hook should be set with the throat and latch in front, so that the latch when half open or about a right angle with the shank, is nearly horizontal.

When properly adjusted, the point of the hook should pass the needle below the fabric in gently but sure contact just above the eye of the needle, and the hook should be bent or sprung slightly if necessary to insure such adjustment.

To adjust the hook to a nicety on fine work, the presser foot and needle plate may be removed to advantage to permit a clear view.

However, before making final adjustment of the hook, see that the hook carrier guide is properly set, according to Section 15.

Hooks and needles must be suitable for the individual machine.

Hook Carrier Guide

15. The hook carrier guide must be adjusted as closely as possible to the hook carrier, so that the latter shall have no lost motion laterally and yet be PERFECTLY FREE to travel its full stroke in either direction, below, around the edge and above the fabric. Any lost motion of the hook carrier laterally, that is, toward or away from the hook carrier guide, is very likely to produce imperfect stitching.

The adjustment of the hook carrier guide is secured by means of a screw at the left hand end of the machine, above the work plate.

Finger Plate

16. The finger plate around which the stitches are formed, must be set into the machine sufficiently to deflect the loops to hold them into the throat of the hook, but must not be set in so far as to be hit by the hook as it travels around the edge of the finger plate.

The Feed

(PLAIN CROCHET MACHINES)

17. To change the length of feed, remove the screw at the left hand end of the main shaft, and substitute for the feed cam, one of the desired number.

The feed cams are marked, indicating approximately the number of stitches to the inch of finish along the edge of the fabric.

Set the feed dog as low as possible and yet properly feed the fabric.

The Feed

(SHELL STITCH MACHINES)

18. The length of the feed is adjustable by means of the feed adjusting nut and bolt on the feed lever. The higher this nut is adjusted on the feed lever, the shorter will be the feed, and conversely the lower the nut is adjusted, the longer will be the feed.

The length of the feed should be suited to the fabric, the size of yarn or thread, and the number of stitches to the shell. If the normal adjustment of the length of the feeding is not as desired, a feed eccentric of different throw would be required.

The feed dog should be set as low as possible and properly carry the fabric. The feed dog is vertically adjustable in all machines recently made, and parts needed for such adjustment can be supplied to fit any of the older machines.

The feed carrier is provided with a wedge, near its forward end at the under side, adjustable by means of a screw at the outer face of the feed carrier. Adjusting this wedge in one direction raises the feed dog, while adjusting in the opposite direction lowers the feed dog.

The number of stitches to the shell is determined by the feed gear and feed raising cams. The feed gear rotates upon a stud which screws into the feed gear support.

Supplemental Thread Carrier

19. The supplemental thread carrier moves back and forth over the presser foot, to carry the extra thread into the throat of the hook, and ordinarily should be adjusted about as low as possible and keep clear of the hook at all times. This supplemental thread carrier is adjustable vertically, and may be rotated partially, by loosening the screw at the left hand end of its rocker shaft, and it may also be adjusted backward or forward by loosening the clamp screw at the upper end of the cam lever on the rocker shaft.

Most of the machines are now provided with a supplemental thread carrier having a finger projecting beyond its thread eye, to carry the needle thread forward as the hook is moving outward over the presser foot, and to carry the needle thread backward into the throat of the hook, while the latter is moving to the right above the presser foot.

This improved supplemental thread carrier should be so adjusted that the needle thread, when diverted forward, will slip off the projecting finger of the carrier, just after the hook has passed outward beyond the line of the needle thread, and so that the finger on its backward movement will be sure to engage the needle thread and carry it into the throat of the hook.

Stitch Controller

20. Many of the older machines are arranged with a stitch controller, which is a small finger being moved up and down at the left hand end of the machine, and its point entering a small hole located in some styles of presser feet.

This stitch controller is actuated by means of an eccentric on the end of the upper shaft, and raising the stitch controller in its carrier has a tendency to tighten the edge, which lowering it tends to make the edge loose. Other things being the same, the longer the feed, the tighter will be the finished edge.

Adding Attachment

21. An adding attachment available for most new machines to order, at a small extra cost, to assist in producing the Collarette Finish, which is made by first finishing the edge of the fabric with a regular course of two thread stitches, and afterwards adding several courses to the very edge of the foundation course.

This adding attachment or guide, is secured to the frame cap in front of the machine. First adjust it as far to the right as is necessary to permit the fabric to be fed in the usual depth, then finish the edge of the fabric with one course of the regular two thread finish, after which slide the adding guide to its extreme left hand position, and form one or several courses of two thread thread crochet stitches upon the very edge of the previous course along the lines of double loops at the extreme edge of the finish, or just inside thereof, according to the desired effect.

The finish is more open when the needle penetrates the line of double loops at the very edge, then if the needle penetrates the finish just inside the loops at the edge. This attachment may be applied to the above machines if sent to our Works.

Threading

22. For machines arranged for two thread operation, the course of the thread is shown on either page 18 or 19. Further description of the adjustments are in the following Sections 23 and 24.

For single thread operation, the needle thread follows the course shown on page 19 using no adjustable thread guide and non supplemental thread.

Adjustable Thread Guides and Takeup for Needle Thread

23. The needle thread should pass from the thread stand, downward diagonally to the thread eye in the rear of the right hand tension, thence between the tension discs, over the tension rod, thence downward and through the **outer** hole in the needle thread takeup, thence diagonally downward and through the **lower** of the three adjustable thread guides, secured to the left hand side of the head of the machine, thence diagonally downward and through the thread eye in front of the lower part of the head of the machine, and finally downward and through the eye of the vertical needle, from the front. See page 18.

The **lower** adjustable thread guide influences the length of needle thread which goes to make up the stitches, hence raising this guide has a tendency to produce a looser stitch, while adjusting this guide downward has a tendency to tighten the stitches.

Ordinarily this adjustable thread guide should be set so that when the needle is at its highest position, the needle thread takeup which moves with the needle bar, will just take the slack out of the needle thread without drawing any needle thread through the tension discs. Therefore, if needle thread is being drawn through the tension discs when the needle bar reaches its uppermost position, the lower adjustable thread guide should be raised slightly to cause the needle thread to be sufficiently drawn through the tensions on the downward stroke of the needle bar.

The lower adjustable thread guide is not present in all machines, and its use may be dispensed with to advantage on some kinds of work or practically all machines making large shells, but it is especially useful on machines making small shells and the plain crochet stitch. See page 19.

Adjustable Thread Guide and Takeup for Supplemental Thread

24. The supplemental thread passes through a thread eye at the left hand side of the head of the machine, thence between the tension discs, thence downward through the **upper** adjustable thread guide, thence through the **inner** hole in the needle thread takeup, thence to the left diagonally downward through the **middle** adjustable thread guide, thence diagonally downward through a thread eye in the head of the machine, and finally through the eye in the supplemental thread carrier. (See Section No. 22 for threading diagram.)

The **middle** adjustable thread guide influences the length of the supplemental thread which goes to make up the purl or edge of the finish, and raising this guide increases the length of the supplemental thread used in each stitch and hence makes a looser edge, while adjusting this guide downward, tends to produce the opposite effect.

The **upper** adjustable thread guide influences the uniformity of the stitches at the edge, by slightly taking up the supplemental thread. Raising this guide has a tendency to increase the looseness of the edge of the finish, while setting this guide downward has a tendency to tighten the edge of the finish. This guide should never be set so low as to cause the supplemental thread to be drawn through the tension discs as the needle approaches its uppermost position.

A preliminary adjustment of the three adjustable thread guides may be made after threading and before starting with the upper guide set quite close to the supplemental thread tension discs; the middle guide set at a slight angle below its horizontal position, the lower guide set at quite an angle below its straight position bringing its thread hole down near the frame of the machine. Operating results of this adjustment may be noted and then the guides further adjusted in accordance with the foregoing instructions and also the instructions in Section No. 23.

The adjustable takeup guides for the needle thread and for the supplemental thread should be set in such relation to each other that the edge loops will be uniform.

Careful adjustment of these three adjustable thread guides is recommended where the best results are desired, and these adjustments should be made in suitable relation to the adjustment of the moving cast off horn in the following section.

The Moving Cast Off Horn

25. The moving cast off horn acts to hold back the loops on the crochet hook, so that the latch of the hook will surely pass through the loops on the hook, while the latter is moving toward the left above the work, and also to control the length of supplemental thread which goes into the purl or edge loops.

The moving cast off horn may be set into its carrier such a distance that the lower pointed end of the horn will be carried far enough back in its stroke away from the operator, to cause the supplemental thread, between the supplemental thread carrier and the throat of the crochet hook, to surround the moving horn while the crochet hook is drawing thread from the needle and from the supplemental thread carrier, and the moving cast off horn must be set far enough forward, toward the operator, to permit the horn to draw out of the loops formed around it, and to clear the needle thread, so that as the horn again moves backward it will pass over the needle thread and over the supplemental thread.

The sidewise adjustment of the moving cast off horn is made by loosening the clamp screw in the cast off carrier, and swinging the lower part of the horn toward or away from the presser foot. If the horn is set too far to the right, the stitches are likely to bind on the crochet hook, and if set too far to the left, it may not always pass over the supplemental thread, and cause an irregular finish. If the purl or chain along the edge is too loose, the horn may be adjusted slightly toward the operator. Be sure to firmly tighten the clamp screw after adjusting the horn.

For some classes of work the moving cast off horn may be considerably shortened (or adjusted towards the operator) so that the threads will not surround the cast off horn while the crochet hook draws the needle thread and supplemental thread above the work.

Stationary Cast Off Horn

26. Some of our machines are provided with an adjustably stationary cast off horn, which should be adjusted with its rear end about horizontal, just high enough to hold back the loops on the crochet hook while the latter is moving outward above the finger plate and presser foot, but not high enough to be hit by the hook.

Tensions

27. The tension of the two threads should be light but perceptible, and both may be about alike.

When a single thread finish is desired, remove the supplemental thread without change or adjustment of the machine, except possibly the tension of the needle thread.

When two threads are used in the needle, each thread should be passed through a separate tension, that is, the extra thread used should be passed through the tension provided for the usual supplemental thread.

Thread Stops

28. A thread stop is attached to the presser foot in many of the styles 22 and 27 machines. This thread stop is for the purpose of preventing the needle thread from passing back so far that it may not be caught by the crochet hook, as the latter travels from left to right above the presser foot. The thread stop should be adjusted as far back as possible and yet not permit the needle thread to pass back far enough to allow the crochet hook to pass in front of it.

Fabric Guard

29. Some of the shell stitch machines are provided with a fabric guard, which should project somewhat above the edge of the fabric, outside the purl or chain at the edge of the finish, and assist in holding the threads from previous loops while the crochet hook is drawing threads through the old loops to form a new set of loops. In other words, it acts to help the crochet hook to shed its loops while making new loops, and for this purpose should be set as near to the edge of the finger plate as is practicable and have ample space for the free passage of the loops, and it should also be set as near the path of the crochet hook as possible, and yet never permit the hook to come in contact with it.

Eight Stitch Shells

30. When using the eight stitch feed gear, the feed gear support must be placed in its groove in the left hand face of the machine below the work plate, with its

rear end against a stop pin and with its screw threaded hole **BELOW** its center and the recessed or routed corners being outside.

Observe that the dash — marked upon the face of the gear matches the dash — marked upon the small pinion at the outer left hand end of the main shaft. If the feed gear is misplaced even a single tooth, the action of the feed will not be perfect.

When using the eight stitch feed gear provided with one feed raising cam, the shells will be made with eight stitches each.

The feed raising cams for the eight stitch feed gear will not fit other kinds of feed gears.

Four Stitch Shells

31. The eight stitch gear is made so that an extra feed raising cam may be secured thereon diametrically opposite the one usually employed, and when so arranged, shells of four stitches each will be made.

Four and Eight Stitch Shells

32. Some machines having the **STITCH CHANGING** devices, are arranged with an eight stitch feed gear, as described in Section 30, to which is secured one thin and one thick feed raising cam, for producing either four or eight stitch shells as desired.

Shifting the stitch changing mechanism, as described in Section 41, causes the feed raising roll, mounted on the feed raising lever, to come in contact with the thick feed raising cam, for eight stitch shells, or with both the thick and thin feed raising cams for four stitch shells. See Section 33.

33. Some shell stitch machines having the **STITCH CHANGING** devices, are arranged with an improved eight stitch feed gear and an improved four stitch feed raising cam mounted thereon, illustrated on page 36. Also, mounted upon the face of this four stitch feed raising cam, is another small raising cam for producing shells of eight stitches.

Through the action of the stitch changing mechanism described in Section 41, either four stitch shells or eight stitch shells may be made at will. Shifting the stitch changing mechanism, causes the feed raising lever pin shown in page 36 to come in contact with the four stitch feed raising cam for four stitch shells, or with the small feed raising cam mounted thereon, for the eight stitch shells.

Adjust the length of the feed for the eight stitch shells, as described in Section 18, then adjust the length of the four stitch shells by loosening the two screws which secure the four stitch feed raising cam to the feed gear, and move it slightly forward or back on the hub of the feed gear, to accomplish an earlier or a later feeding, as desired. Then tighten the screws and test.

Feed Raising Cam for Plain Stitch

34. Some of the shell stitch machines are adapted to use the feed raising cam for plain stitch, shown on page 34, and a feed eccentric of shorter throw, to produce the plain crochet finish. This arrangement is recommended only for temporary use in a small way, as the **PLAIN CROCHET MACHINES** should be used if any considerable production is required.

To change one of the machines from **SHELL STITCH** finish to the **PLAIN CROCHET** finish, remove the eight stitch feed gear and the feed raising cam or cams attached to it, and screw the feed raising cam for plain stitch to the inner

surface of said feed gear. Then remove the feed connection and feed eccentric, and in place of the latter, secure the feed eccentric of shorter throw, and replace the feed connection and eight stitch gear to their former position. The throw of the feed must be short for plain stitch. See Section 18.

Eight Stitch Shells and Plain Crochet

35. Machines having the STITCH CHANGING devices may be arranged with an improved 8 stitch feed gear and an improved multiple feed raising cam for plain stitch mounted thereon, illustrated by the larger one on page 36. Also, secured upon the face of the feed raising cam for plain stitch, is a single feed raising cam for producing shells of eight stitches.

Through the action of the stitch changing mechanism described in Section 41, either eight stitch shells, or the plain crochet finish may be made at will. Shifting the stitch changing mechanism, causes the feed raising lever pin shown on page 36, to come in contact with the large multiple feed raising cam for plain crochet finish, or with the single feed raising cam mounted thereon, for the eight stitch shell finish.

Six Stitch Shells

36. When using the six stitch feed gear, the feed gear support must be placed in its groove in the same manner as for the eight stitch feed gear described in Section 30, except that the screw threaded hole in the support must be ABOVE its center instead of BELOW. In other words, it must be turned the opposite end around, but the **same side** out.

When using the six stitch feed gear provided with one feed raising cam, the shells will be made with six stitches each.

Three Stitch Shells

37. The six stitch feed gear is made so that an extra feed raising cam may be secured thereon, diametrically opposite the one usually employed, and when so arranged, shells of three stitches each will be made.

The feed raising cams for the six stitch feed gears will not fit other kinds of gears.

Three and Six Stitch Shells

38. Some machines having the STITCH CHANGING devices, may be arranged with a six stitch feed gear, as described in Section 36, to which is secured one thin and one thick feed raising cam, for producing either three stitch shells or six stitch shells as desired.

Shifting the stitch changing mechanism, as described in Section 41 causes the feed raising roll, mounted on the feed raising lever, to come in contact with the thick feed raising cam for six stitch shells, or with both the thick and thin feed raising cams for three stitch shells..

Six Stitch Shells and Plain Crochet

39. Machines having the STITCH CHANGING devices, may be arranged with an improved six stitch feed gear, and an improved multiple feed raising cam for plain stitch, mounted thereon, illustrated by the smaller one on page 36, also, secured upon the face of this multiple feed raising cam for plain stitch, is a single feed raising cam for producing shells of six stitches.

Through the action of the stitch changing mechanism described in Section

41, either six stitch shells or the plain crochet finish may be made at will. Shifting the stitch changing mechanism, causes the feed raising lever pin, shown on page 36, to come in contact with the multiple feed raising cam for plain finish, or with the single feed raising cam mounted thereon for six stitch shell finish.

Special Feed Gears

40. Feed gears for producing respectively five or seven stitches to the shell are occasionally used, and the gears are so marked.

Either the five stitch or the seven stitch feed gear is provided with only one feed raising cam, and a different feed gear support must be used, to which either of the two feed gears may be attached, but which is not suited to the eight stitch or six stitch gears. This feed gear support is adjusted in practically the same manner as the usual support, but is not to be turned end for end in changing the gears. Two screw threaded holes are provided in this support, and the feed gear stud goes into the uppermost screw threaded hole for the five stitch feed gear, and into the lower screw threaded hole for the seven stitch feed gear.

Stitch Changing

41. The change from one variety of finish to another may be made by a simple movement of a thumb knob, located at the upper end of the stitch changing lever, which is operatively connected with the feed raising lever slide, at the front of the machine.

When the thumb knob is at its extreme left hand position, one variety of finish is continuously produced, and when the thumb knob is at the extreme right hand position, another variety of finish is continuously produced.

One great advantage of this system is that the first course of finish, made rather deeply into the fabric, may be made with a rather tight straight edge, this supporting and holding the edge of the fabric and preventing undue extension or pouting.

Fabric Edge Guide

42. The object being to place a second course of edge finish very near the edge of the first course of finish and to change the character of the stitching, it is necessary or desirable to first adjust the fabric edge guide with its free end near but just a little to the right of the line of stitching, when the thumb knob is in its extreme left hand position. It may be necessary to turn the hand wheel slightly to permit the full movement of the thumb knob.

Then move the thumb knob to its extreme distance to the right, and adjust the stitch changing lever link stud upward or downward in the curved slot in the stitch changing lever, until the fabric edge guide is located approximately right to permit the needle to penetrate the fabric at a suitable distance from its edge, for producing the first course of finish.

When later the thumb knob is again moved to its extreme left position, the fabric edge guide will then be in the same position as when previously adjusted.

Now with the thumb knob in its extreme right hand position, make one course of finish on the edge of a piece of fabric such as it is desired to finish, as a trial for the depth of finish. If the depth of the finish is not exactly right, then with the thumb knob still in the extreme right hand position, adjust the stitch changing lever link screw, to carry the fabric edge to the proper place. Do not loosen the screw which holds the fabric edge guide at this time.

Then finish an edge of a small piece of fabric and remove it from the machine,

and afterwards set the thumb knob to its extreme left position and make the second course along the edge of the first course. Then make any very slight adjustment of the fabric edge guide which may be necessary, by means of the screw which passes through the fabric edge guide shank.

The stitch changing lever link is made so that its right hand end may be swung upward to unhook it, and thus disconnect it from the stitch changing lever.

If it is desired to make a deep finish of one kind for a time, and at another time to make a deep finish of the other kind, of the two possible varieties, set the thumb knob to the extreme right hand position and then unhook the stitch changing lever link, without at all disturbing the fabric edge guide, and the machine will be prepared to make one of the two possible kinds of finish, both deeply into the fabric.

Taping

43. The cuts on page 20 illustrate the method of handling the tape or ribbon in machines which are provided with a presser foot lifter operated by a treadle, thus permitting the free use of the hands of the operator.

To introduce the tape, commence with the needle above the cloth and the crochet hook holding the thread well to the right, as shown in Figure IV, and with the stitches properly formed. The tape or ribbon is passed through a hole in the flat tension spring, from right to left, and naturally passes through an opening in the tension spring support, when it is grasped by the thumb and finger of the left hand as shown in Figure I. The end of the tape is then carried forward and upward, causing the rear edge of the tape to lead upward in the vertical slot from the round hole in the flat tension spring, as shown in Figure II.

The tape is then carried backward and to the left, which carries it into the recess in the upper end of the tape tension support as shown in Figure III. Thence the tape is carried downward and to the fabric on the work plate, then backward and under a projecting horn or guide, as shown in Figure IV, when the presser foot must be raised by the foot of the operator, and the tape carried rearward under the presser foot, with the end of the tape extending beyond the presser foot, to provide desired length, as shown in Figure VI.

The tape guide and fabric edge guide should be so adjusted that the needle will not penetrate the tape while being fed along with the fabric. Then operate the machine until the edge of the fabric is finished the desired distance, stopping with the needle above the work and the crochet hook holding the needle thread as shown in Figures IV and V.

To discontinue the inclusion of the tape within the shells, draw through the tension a suitable length of the tape to form one end of the tie or bow, and sever the tape about an inch from the tape tension support, leaving the end of the tape projecting conveniently to be grasped later, still holding the tape with the left thumb and finger, as shown in Figure VI.

Raise the presser foot by the foot lifter treadle, hold down the fabric with the right hand and pass the free end of tape rearward and under the presser foot, draw the tape sufficiently to clear the needle and then the free end of the tape will be under the presser foot and over the edge finish, when the edge finish may be continued or the goods may be pushed to the left away from the needle and the machine operated a few stitches to "chain out."

On the later machine, a trough shaped taped guide, as illustrated on page 36

adjustably secured to the fabric guide shown on page 35 is interposed between the tape tension support and the fabric edge guide.

This tape guide may be adjusted to fold or double the tape, so that wide tape may be fed into a shell finish, thus giving wide tape ends for making the tie or bow. When so used, the lower end of the trough shaped portion of the tape guide should be raised well above the goods, and the folded tape allowed to be held in the folded condition by running under the extension of the fabric guide, which is in position over the goods.

When inserting the tape in this trough shaped guide, the index finger of the right hand may be used to hold the tape into the trough shaped portion, while the left thumb and index finger are used in conducting the tape rearward and under the presser foot.

If it is desired to run a narrow tape without folding, set the lower end of the trough shaped portion of this guide so as to just clear the fabric, and then insert and run the tape as explained.

When it is desired to make a single course of shells around the neck or other portion of a garment, either with or without tape, with the shells deep into the fabric and with the largest number of stitches per shell that the feed gear will produce; and then continue the finish down the front of the garment with shells of the same number of stitches, but placed near the edge of the fabric, set the thumb knob to the right to locate the fabric edge guide for deep finish, then raise the right hand end of the link between the fabric guide slide and the stitch changing lever to disconnect the stitch changing devices from the edge guide, then move the thumb knob to the left to set the stitch changing devices. Finish around the neck commencing at the point most distant from the side of the front opening to be finished, and when the neck is finished (stop preferably with the needle above the fabric with the last shell completed) move the **edge guide and its slide** to the left and hook the free end of the link into the stitch changing lever and proceed to finish down the front edge with shells near the edge of the fabric. The depth of this shell may be located by suitably adjusting the edge guide upon its slide.

When it is desired to make shells as aforementioned, but with the smallest number of stitches produced by the feed gear, commence with thumb knob at the right and finish the course of shells around the neck, and then move the thumb knob to the left to locate the fabric edge guide, then release the link between the fabric guide slide and the stitch changing lever and throw the thumb knob to the right to set the stitch changing devices, and then finish down the front.

When it is desired to make shells of the same depth and of the same number of stitches per shell around the neck and down the front of the garment, the thumb knob and the fabric edge guide need not be adjusted after having been suitably set.

If it is desired to have the tape appear on the inside of the back of the neck opening, and not appear under the shells on the outside of the garment, the finish should be started with the inside of the garment next to the presserfoot. If the outside of the garment is next to the presser foot, the ribbon or tape will appear on the outside of the neck opening. Other variations will be obvious.

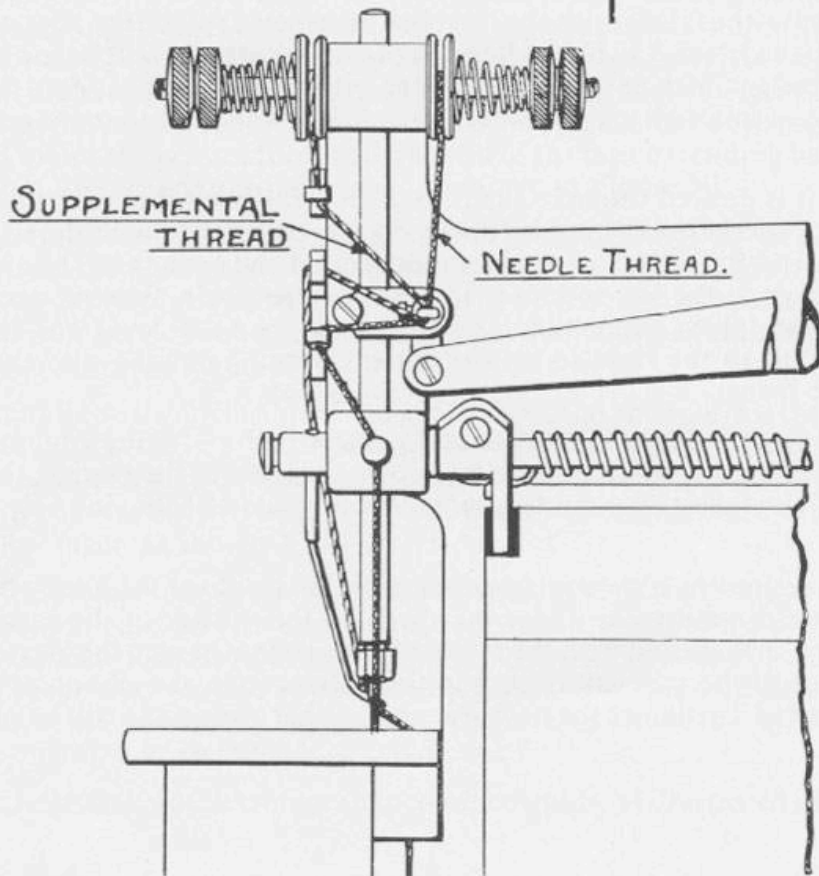
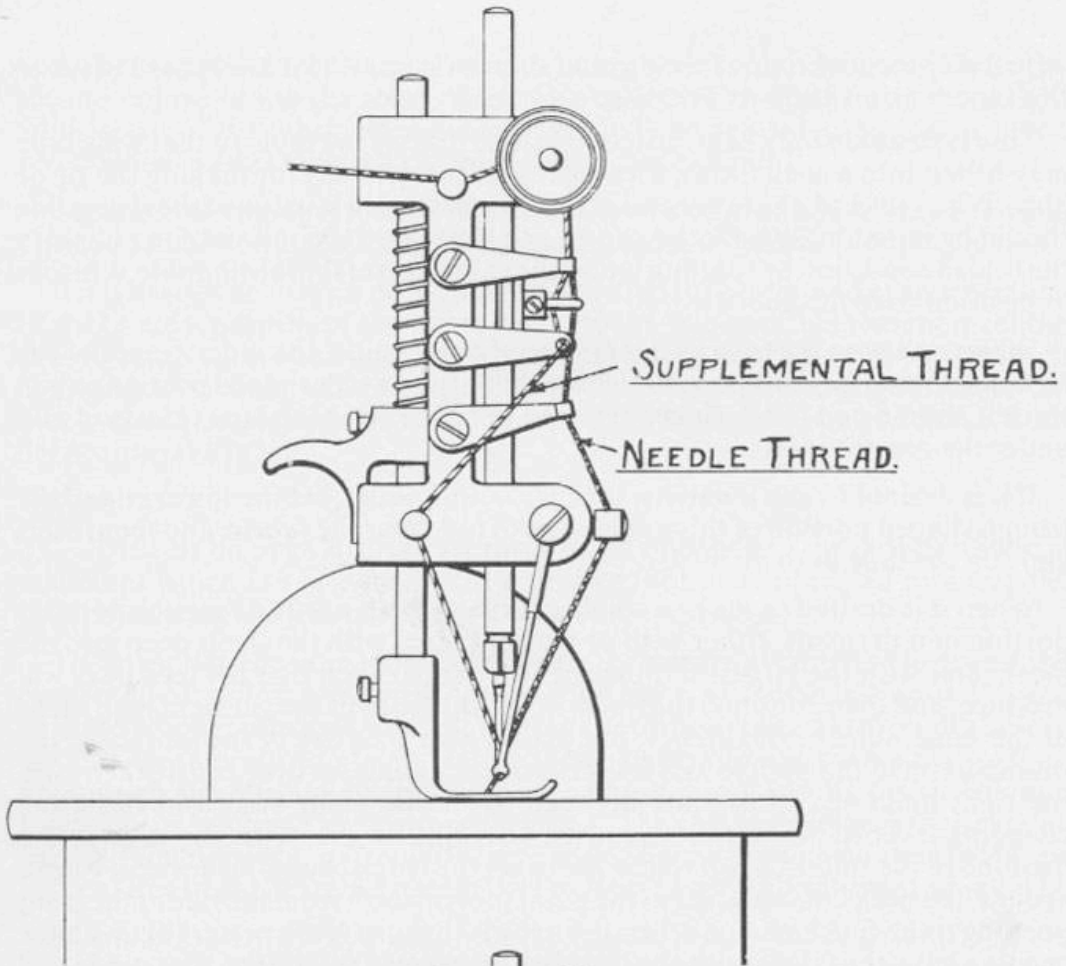

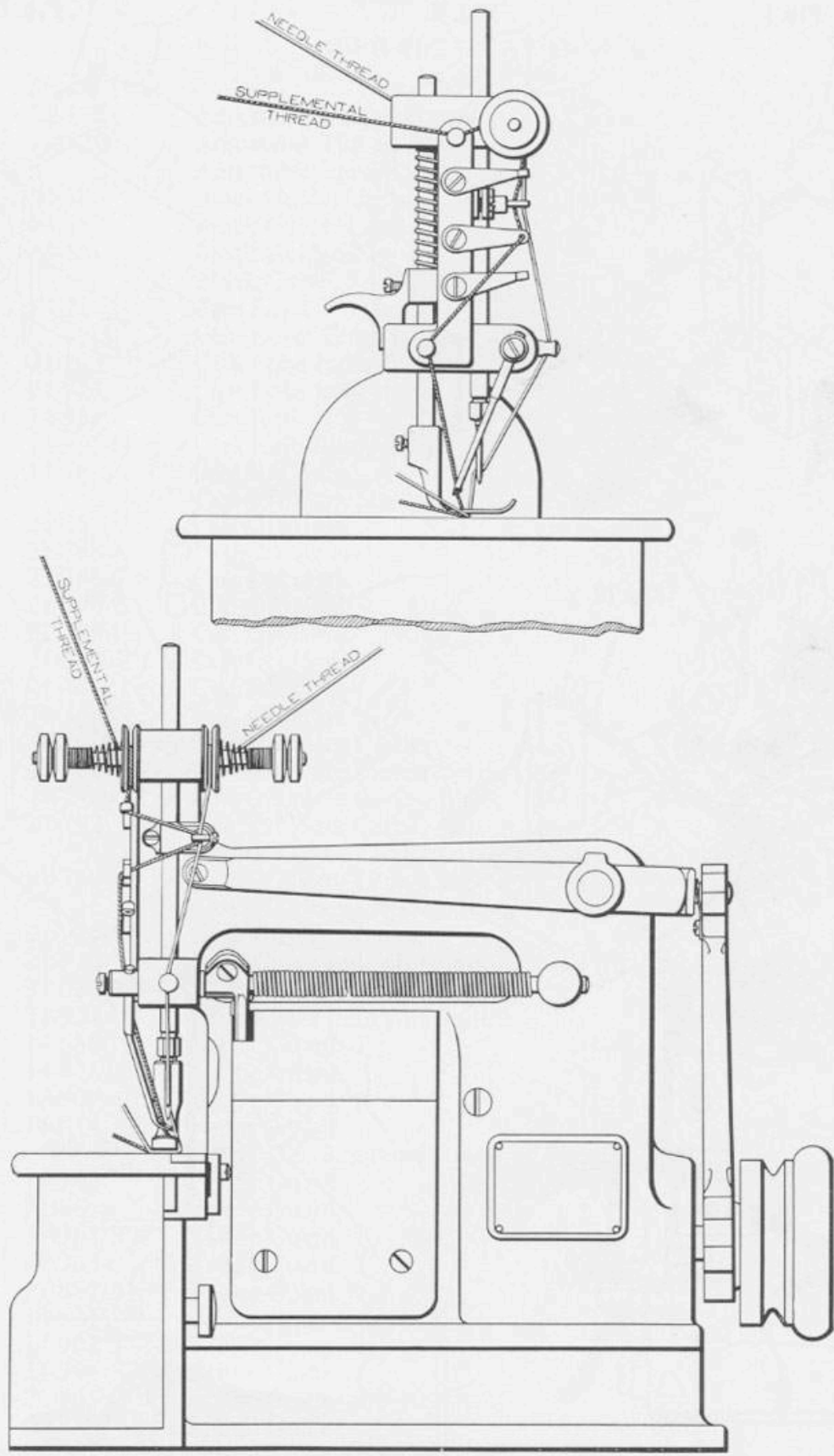

THREADING No.56.

STYLE

MACHINE No.

FIG. I.

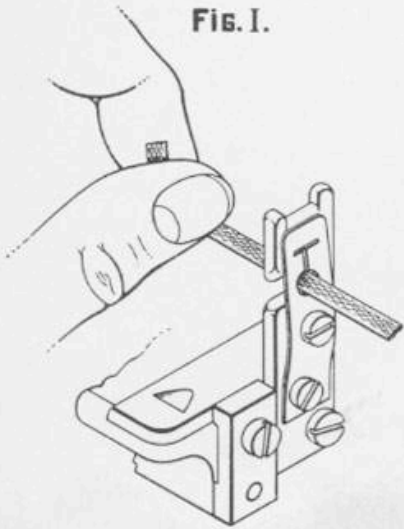

FIG. II.

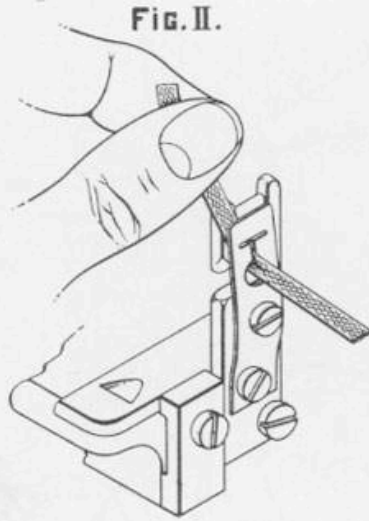

FIG. III.

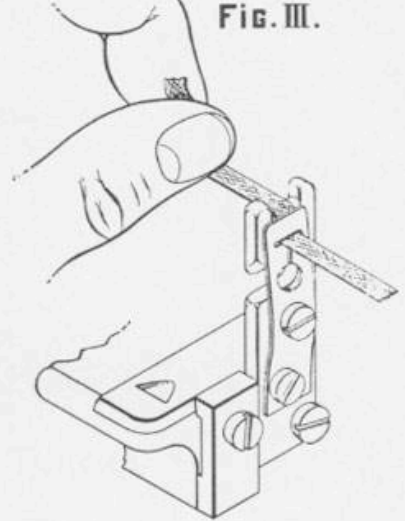

FIG. IV.

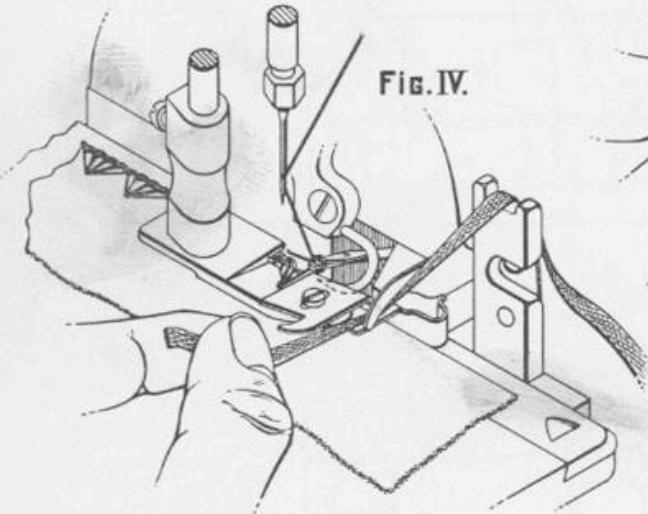

FIG. V.

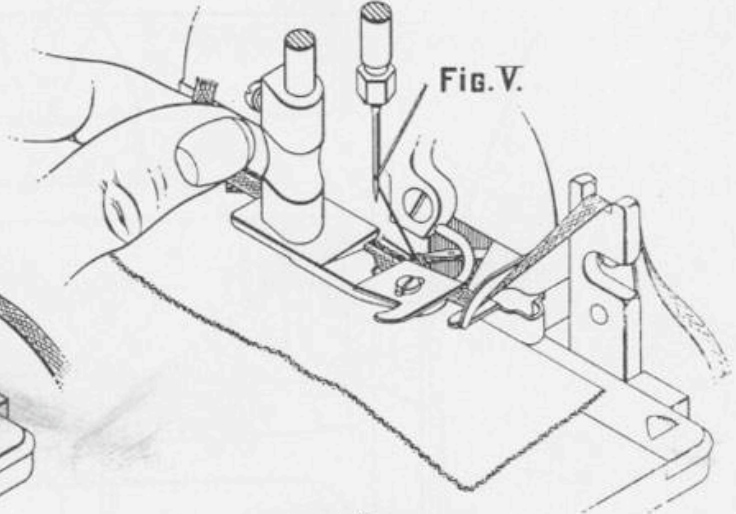

FIG. VI.

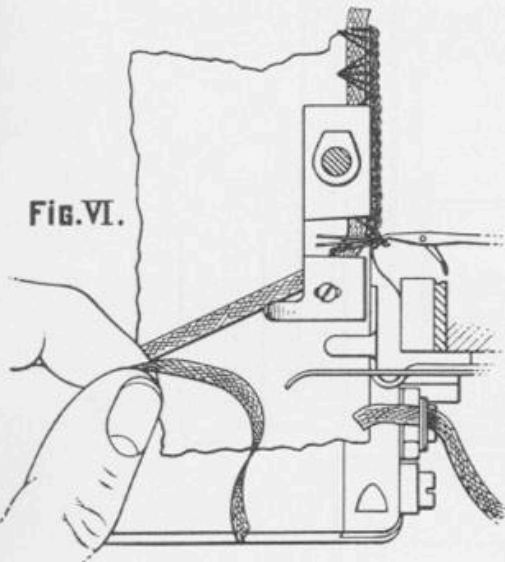
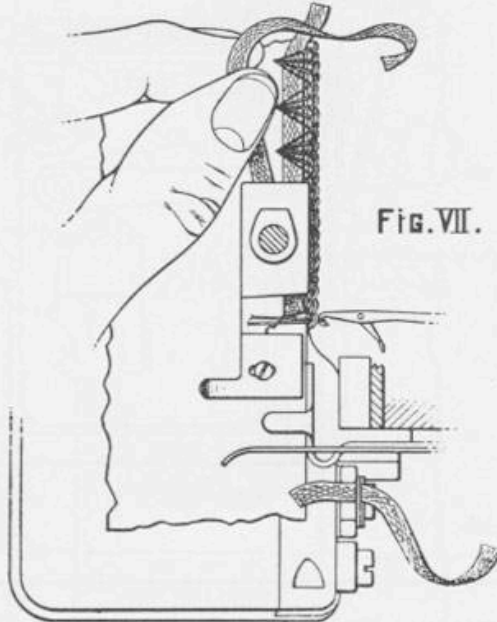

FIG. VII.



TAPING METHOD No. 19.

MACHINE No.

ALPHABETICAL INDEX

<i>Model</i>	
21-778	Adjustable Thread Guide
21-779	Adjustable Thread Guide
	Adjustable Thread Guide Screw 5-3/16
14-50	Block Guide, Upper
14-51	Block Guide, Lower
14-15	Block Guide, Key
	Block Guide, Key Screw 4-3/16
14-11	Cam Lever
	Cam Lever Screw 6-3/16
21-923	Cam Lobe Indicator
21-924	Cam Lobe Indicator
14-455	Cam Roll
14-455-D	Cam Roll, Barrel Shape
14-76 ✓	Cast Off Horn
	Cast Off Horn Screw 6-3/16
21-75	Cast Off Horn
21-788-A	Cast Off Horn
21-788-C	Cast Off Horn
21-788-E	Cast Off Horn
21-788-F	Cast Off Horn
21-788-G	Cast Off Horn
21-788-H	Cast Off Horn
21-788-K	Cast Off Horn
21-790	Cast Off Horn Carrier
	Cast Off Horn Carrier Screw 13-3/16
21-791	Cast Off Horn Carrier Block
21-792	Cast Off Horn Carrier Cap
	Cast Off Horn Carrier Cap Screw 10-3/16
21-789	Cast Off Horn Clamp
	Cast Off Horn Clamp Screw 25-5/32
21-926	Edge Guide Indicator
21-930	Edge Guide Indicator Bushing
21-930-A	Edge Guide Indicator Bushing
21-927	Edge Guide Indicator Scale
14-680	Fabric Guard
14-826	Fabric Guard
14-907	Fabric Guard
14-914	Fabric Guard
	Fabric Guard Screw 5-3/16
14-945	Fabric Guard
21-66	Fabric Guard
21-763-B	Fabric Guard
21-763-C	Fabric Guard
21-877-B	Fabric Guard
14-831	Fabric Guide
14-902	Fabric Guide
21-794	Fabric Guide
21-805	Fabric Guide
21-879	Fabric Guide
	Fabric Guide Screw 18-3/16
	Fabric Guide Washer 1-3/16
21-808	Fabric Guide Slide

21-822	Fabric Guide Slide Spring
21-478	Feed Adjusting Bolt
21-575	Feed Adjusting Wedge
14-96	Feed Carrier
	Feed Carrier Spring 27-3
14-530 ✓	Feed Carrier
	Feed Carrier Spring 27-4
21-579	Feed Carrier
	Feed Carrier Spring 27-7
14-646	Feed Carrier Stud
	Feed Carrier Stud Screw 5-1/4
21-510	Feed Carrier Stud
21-948	Feed Connection Bushing
21-524	Feed Cover
21-524-A	Feed Cover
21-511	Feed Cover Fastening Screw
21-931	Feed Cover Plate
14-214	Feed Dog
14-647	Feed Dog
14-836-A	Feed Dog
14-908	Feed Dog
	Feed Dog Screw 16-3/16
14-946	Feed Dog
21-36	Feed Dog
21-546	Feed Dog
21-824	Feed Dog
21-834	Feed Dog
21-878	Feed Dog
21-719	Feed Dog Stud
14-454	Feed Eccentric, No. 4, 5, 6, 8, 10, 12, 14 Stitches
14-617 ✓	Feed Eccentric, No. 3 Stitch
14-621	Feed Eccentric, No. 2 Stitch
	Feed Eccentric Screw 18-3/16 for #14-454, 14-617 & 14-621
21-89	Feed Eccentric, 20/64" Throw, Scallop
21-190	Feed Eccentric, 4/64" Throw, Scallop
21-248	Feed Eccentric, 10/64" Throw, Scallop
21-586	Feed Eccentric, 9/32" Throw, Scallop
21-699	Feed Gear
21-846	Feed Gear
21-898	Feed Gear
21-920	Feed Gear
21-925	Feed Indicator
21-16-A	Feed Lever
21-53	Feed Lever Connection
21-14	Feed Lever Stud
	Feed Lever Stud Screw 5-1/4
21-189	Feed Raising Cam
21-399	Feed Raising Cam
21-399-C	Feed Raising Cam
21-795	Feed Raising Cam
21-795-A	Feed Raising Cam
21-847	Feed Raising Cam
21-848	Feed Raising Cam 8 Stitch with 21-847

21-881-A	Feed Raising Cam
	Feed Raising Cam Screw 4-3/16
	Feed Raising Cam Screw 55-3/16
21-881-B	Feed Raising Cam
21-897	Feed Raising Cam
21-900	Feed Raising Cam
21-921	Feed Raising Cam
21-922	Feed Raising Cam
21-580-B	Feed Raising Lever
	Feed Raising Lever Screw Stud 17-1/4
	Feed Raising Lever Screw 1-3/16
21-580-C	Feed Raising Lever
21-819	Feed Raising Lever Fork
21-577	Feed Raising Lever Pin – For Style 22 & 27
21-849	Feed Raising Lever Pin
21-849-A	Feed Raising Lever Pin
21-512	Feed Raising Lever Roll – For Style 22 & 27
21-809	Feed Raising Lever Slide
	Feed Raising Lever Slide Screw 49-3/16
	Feed Raising Lever Slide Screw 50-3/16
21-823	Feed Raising Lever Slide Bushing
21-588	Feed Stop
21-681	Feed Stop
14-85	Finger Plate
14-253	Finger Plate
14-828	Finger Plate
14-829	Finger Plate
14-905	Finger Plate
14-913	Finger Plate
21-32	Finger Plate
21-798	Finger Plate
21-799	Finger Plate
21-802	Finger Plate
21-893	Finger Plate
21-901	Finger Plate
14-82	Finger Plate Clamp
	Finger Plate Clamp Pin 36-11
	Finger Plate Clamp Screw 35-3/16
14-25-B	Frame
14-42-A	Frame
21-2-D	Frame
21-157-B	Frame Base
14-2	Frame Cap
14-3-C	Frame Cap
21-869-A	Frame Cap
	Frame Cap Screw 8-3/16
21-869-B	Frame Cap
21-806	Gear Stud Support
21-896-B	Gear Stud Support
14-522-A	Hand Wheel
14-522-C	Hand Wheel
14-522-G	Hand Wheel
	Hand Wheel Screw 11-3/16
14-34	Hemmer

14-465-D	Hemmer
14-465-E	Hemmer
	Hemmer Screw 6-3/16
14-46	Hook Carrier for No. 8 Hook only
14-48	Hook Carrier
	Hook Carrier Screw 3-3/16
14-285	Hook Carrier Block
14-409	Hook Carrier Guide
14-547	Hook Carrier Guide
	Hook Carrier Screw 19-3/16
14-739	Hook Gauge 15/16", 27/32", 29/32", 57/64"
14-17	Needle Bar
14-662	Needle Bar
14-144	Needle Bar Block
	Needle Bar Block Screw 2-5/32
14-542	Needle Bar Bushing
14-717	Needle Bar Bushing
	Needle Bar Bushing Screw 1-3/16
14-186	Needle Bar Link
	Needle Bar Link Screw 14-3/16
	Needle Bar Link Screw 44-3/16 for takeup
14-481	Needle Bar Nut
14-728	Needle Bar Nut
14-648	Needle Guard
14-753	Needle Guard
	Needle Guard Screw 18-3/16
21-765	Needle Guard
21-840	Needle Guard
21-888	Needle Guard
21-894	Needle Guard
21-910	Needle Guard
21-932	Needle Guard
	Needle Guard Screw 10-3/32
21-953	Needle Guard
21-911	Needle Guard Cap
14-916	Needle Guard Holder
	Needle Guard Holder Screw 18-3/16
21-743	Needle Guard Holder
14-68	Needle Lever
14-516	Needle Lever Ball
14-95	Needle Lever Connection
	Needle Lever Connection Screw 9-3/16
	Needle Lever Connection Screw 10-3/16
14-373	Needle Lever Connection Spring
	Needle Lever Connection Spring Screw 10-5/32
14-54	Needle Lever Stud
	Needle Lever Stud Screw 5-1/4
14-39	Needle Lever Thimble
14-539	Needle Plate
14-649	Needle Plate
14-947	Needle Plate
21-35	Needle Plate

21-590	Needle Plate
21-661	Needle Plate
21-698	Needle Plate
21-890	Needle Plate
21-904	Needle Plate
14-756	Presser Bar
	Presser Bar Spring 27-2, Light
	Presser Bar Spring 27-8, Heavy
	Presser Bar Spring 27-9, Extra Heavy
21-874	Presser Bar Bushing
21-860	Presser Bar Guide
	Presser Bar Guide Screw 17-5/32
14-470	Presser Foot
14-548	Presser Foot
14-807	Presser Foot
14-830	Presser Foot
14-906	Presser Foot
14-950	Presser Foot
21-797	Presser Foot
21-949	Presser Foot
21-951	Presser Foot
21-952	Presser Foot
14-79	Presser Foot Block
14-675	Presser Foot Block
	Presser Foot Block Screw 2-5/32
21-884	Presser Foot Extension
	Presser Foot Extension Screw 9-1/8
21-884-A	Presser Foot Extension
21-Assy-1	Presser Foot Lifter Assembly
21-856	Presser Foot Lifter
21-857	Presser Foot Lifter Bracket
14-284	Presser Foot Lifter, Hand Operated
21-858	Presser Foot Lifter Pin
21-859	Presser Foot Lifter Plunger
21-885	Presser Foot Tape Guide
	Presser Foot Tape Guide Screw 2-3/32
14-A-2	Rocker Shaft Includes: Rocker Shaft 14-854
	Rocker Shaft Cap 14-855
	Rocker Shaft Screw 7-3/16
14-854	Rocker Shaft
14-855	Rocker Shaft Cap
	Rocker Shaft Cap Screw 7-3/16
14-528	Rocker Shaft Spring
	Rocker Shaft Spring Washer 1-1/4
14-568	Rocker Shaft Stud
	Rocker Shaft Stud Screw 14-1/4
14-55	Shaft, Upper
	Shaft, Upper Screw 12-1/4
21-793	Shaft, Upper
21-933	Shaft, Upper
14-6	Shaft, Lower
14-6-A	Shaft, Lower
	Shaft, Lower Screw 18-3/16
21-7	Shaft, Lower

14-480	Shaft Stopper, Upper
21-812-A	Stitch Changing Lever
21-812-B	Stitch Changing Lever
21-814	Stitch Changing Lever Bushing
21-814-A	Stitch Changing Lever Bushing
21-928	Stitch Changing Lever Latch
21-871	Stitch Changing Lever Link
21-871-A	Stitch Changing Lever Link
21-817	Stitch Changing Lever Link Bushing
21-818	Stitch Changing Lever Link Bushing
21-929	Stitch Changing Lever Lock
21-815	Stitch Changing Lever Nut
14-536	Supplemental Thread Carrier
	Supplemental Thread Carrier Screw 7-3/16
21-837	Supplemental Thread Carrier
21-872	Supplemental Thread Carrier
21-954	Supplemental Thread Carrier
21-882	Tape Guide
37-318-A	Tape Tension Spring
21-873	Tape Tension Support
14-142	Tension Disc
14-8	Tension Nut
14-8-A	Tension Nut
14-508	Tension Rod – Double Arm
14-523	Tension Rod – Single Arm
	Tension Rod Screw 1-3/16
14-456	Tension Spring Bushing
14-64	Tension Spring – Medium
14-64-A	Tension Spring – Heavy
14-760	Tension Spring – Light
14-457	Thread Guide
14-490	Thread Guide
21-777	Thread Guide
14-5	Work Plate
14-689	Work Plate
21-820-A	Work Plate
21-876-A	Work Plate

Main Cams

<i>Upper</i>	<i>Lower</i>
14-1/16, B-23A	15-1/16
18	18
105-119	106
113-23	114
Cam Screw 10-1/4	

Hooks

No. 6	Hook Crochet
No. 7	Hook Crochet
No. 8	Hook Crochet
No. 36	Hook Crochet
No. 59	Hook Crochet
No. 61	Hook Crochet
No. 40-12-2	Hook Crochet

Needles

No. 2	Needle
No. 3	Needle
No. 4	Needle
No. 4SS	Needle
No. 5	Needle
No. 5A	Needle
No. 6A	Needle
No. 8	Needle
No. 8SS	Needle
No. 10	Needle
No. 10H	Needle
No. 11	Needle

Miscellaneous Accessories

Felt Pad 40-4B
 Oil Can Spring Bottom
 Presser Foot Lifter Treadle 10-3
 Presser Foot Lifter Treadle Chain 6-195
 Presser Foot Lifter Treadle Spring 27-18
 Raising Wood Block 61-3
 Screw Driver 48-3
 Wrench 30-1

HOOK AND NEEDLE COMBINATIONS

<u>Machine</u>	<u>Hook</u>	<u>Needle</u>	<u>Hook Gauge</u>	<u>Hook Carrier</u>
15 A, F	6	8, 10	27/32	14-48
15C, CA, CA-1	59	5, 8, 10H	29/32	14-48
17, 17F	8	6A, 8, 10, 10H	15/16	14-46
18, 18A, E, F	8	8, 10, 10H, 11	15/16	14-46
22F, FJ, FJT, FJT-3	7 or 8	8, 10, 10H, 10, 10H, 11	15/16 15/16	14-48 14-46
24F	61 or 59	5A-8	57/64	14-48
27F, FJ	7 or 59 or 61	8 8 8	29/32 59/64 29/32	14-48 14-48 14-48
35 B, C	36	5	29/32	14-48
35E, F, FJ, FJT	61 or 36	4 4-8	29/32 57/64	14-48 14-48

NOTE: 14-46 has large hook hole (.080)
 14-48 has small hook hole (.070)
 #8 hook largest hook and is made from .080 wire.
 #7 hook smaller hook made of .070 wire and used in 14-48 hook carrier. Hook size in descending order from #7 are #59, #6, #61.

FEED GEAR AND FEED RAISING CAM
COMBINATION FOR SHELL STITCH MACHINES

<u>Number of Stitches Per Shell</u>	<u>Feed Gear</u>	<u>Feed Raising Cam or Cams</u>	<u>Screws</u>
A. Shell Stitch Machines <i>without</i> "J" in Style Number, such as 35F, 27F and 22F			
Plain Crochet (Old)	21-699	21-189	4-3/16 (2)
Plain Crochet (New)	21-846	21-847	55-3/16, 41-3/16, Nut 4-3/16
Three Stitch	21-898	21-399, 21-399-C	55-3/16, 41-3/16, Nut 4-3/16
Four Stitch (Old)	21-699	21-700 disc. use (2) 21-795-A	4-3/16 (2)
Four Stitch (New)	21-846	21-881-A	55-3/16, 41-3/16, Nut 4-3/16
Five Stitch	21-570	21-571	4-3/16
Six Stitch	21-898	21-399	4-3/16
Seven Stitch	21-572	21-573	4-3/16
Eight Stitch	21-699	21-795	4-3/16
B. Shell Stitch Machines <i>with</i> "J" in Style Number, such as 35FJ, 27FJ, 22FJ			
Plain and Three	21-898	EXC-325 (Plain) EXC-326 (three)	41-3/16 55-3/16
Plain and Four	21-846	21-847 (Plain) 21-881-B (Four)	41-3/16 55-3/16
Plain and Six	21-898	21-897 (Plain) 21-900 (Six)	4-3/16 55-3/16
Plain and Eight	21-846	21-847 (Plain) 21-848 (Eight)	4-3/16 55-3/16
Three and Six	21-898	21-399, 21-399-C (Three) 21-900 (Six)	4-3/16 55-3/16
Four and Eight	21-846	21-881-A (Four) 21-848 (Eight)	4-3/16 55-3/16
C. Shell Stitch Machines <i>with</i> "J-3" in Style Number, such as 27FJT-3, 22FJT-3			
Plain, Four & Eight	21-920	21-921 (Plain) 21-922 (Four)	41-3/16 64-3/16

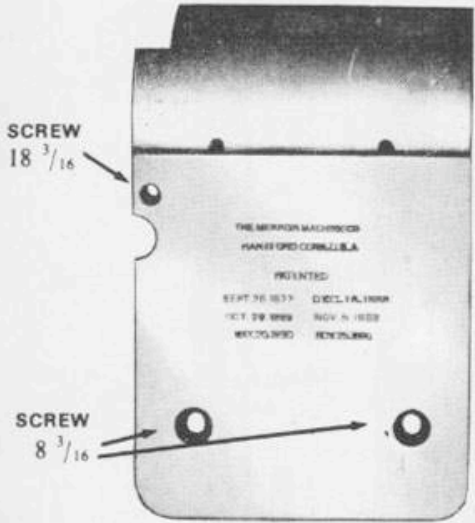

FRAME CAP



BLOCK GUIDE KEY
14-15



BLOCK GUIDE UPPER
14-50



BLOCK GUIDE LOWER
14-51



HOOK CARRIER GUIDE
14-409



HOOK CARRIER BLOCK
14-285



HOOK CARRIER
14-48
or
14-46

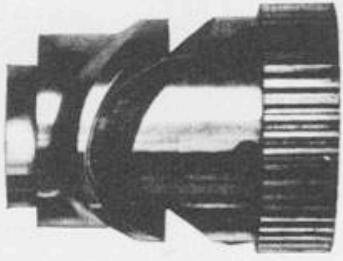

UPPER CAM

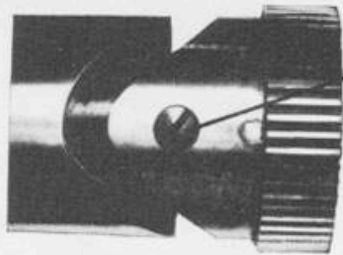

LOWER CAM



CAM ROLLER
14-455-D



CAST OFF HORN
14-76

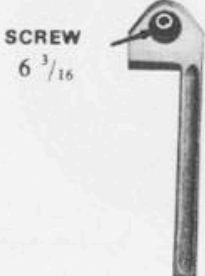

CAM LEVER
14-11

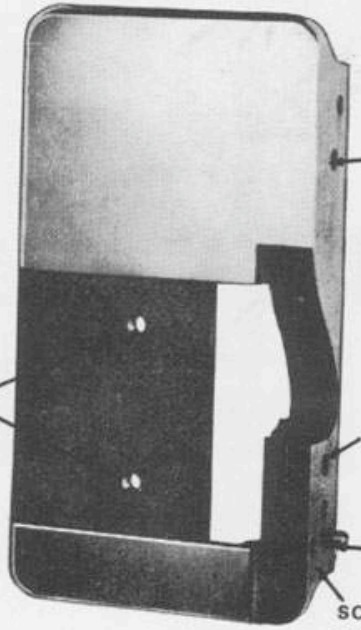
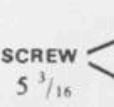

WORK PLATE

SCREW
71 3/16

SCREW
18 3/16

PIN
36-11

SCREW
35 3/16

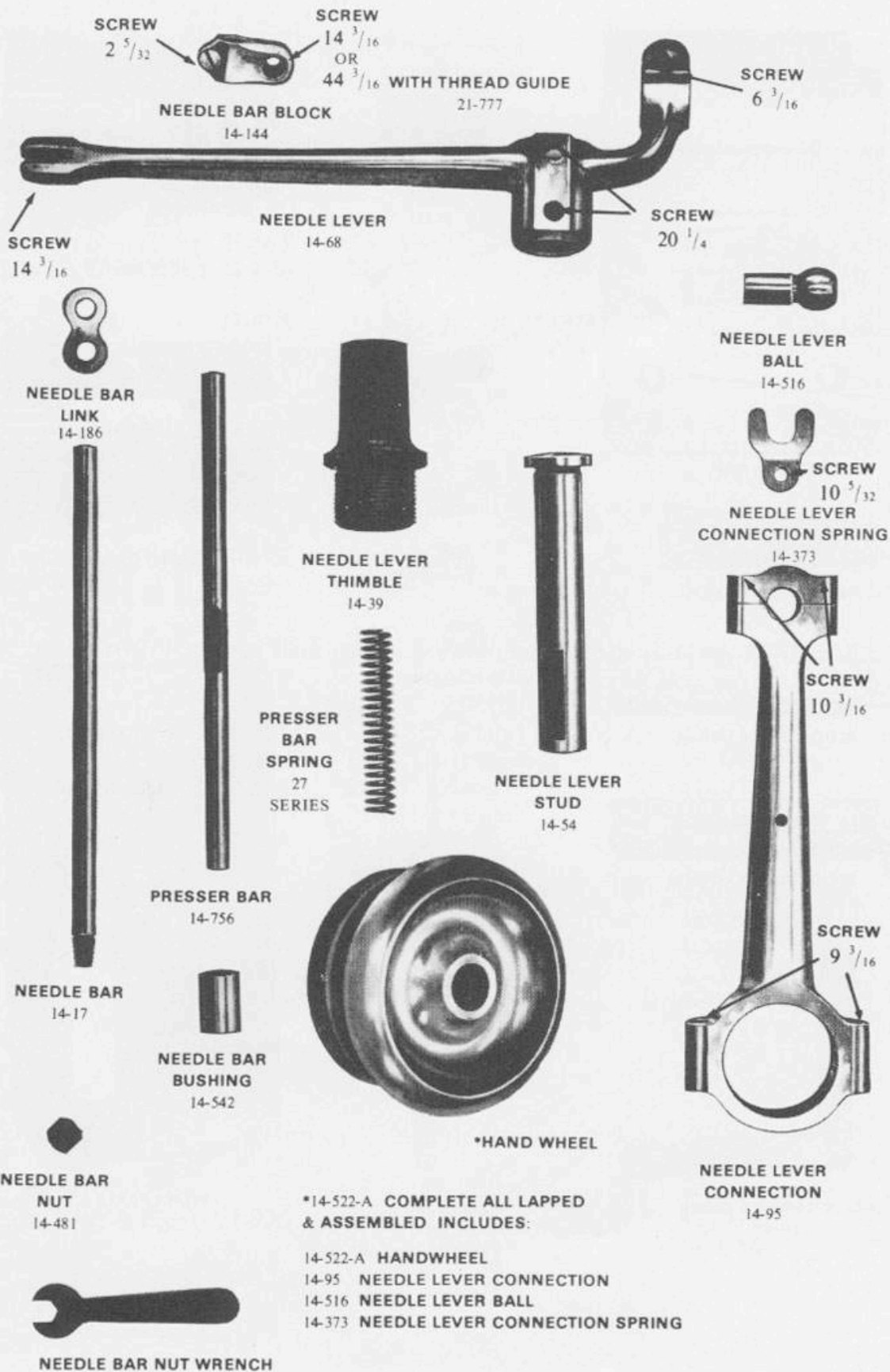

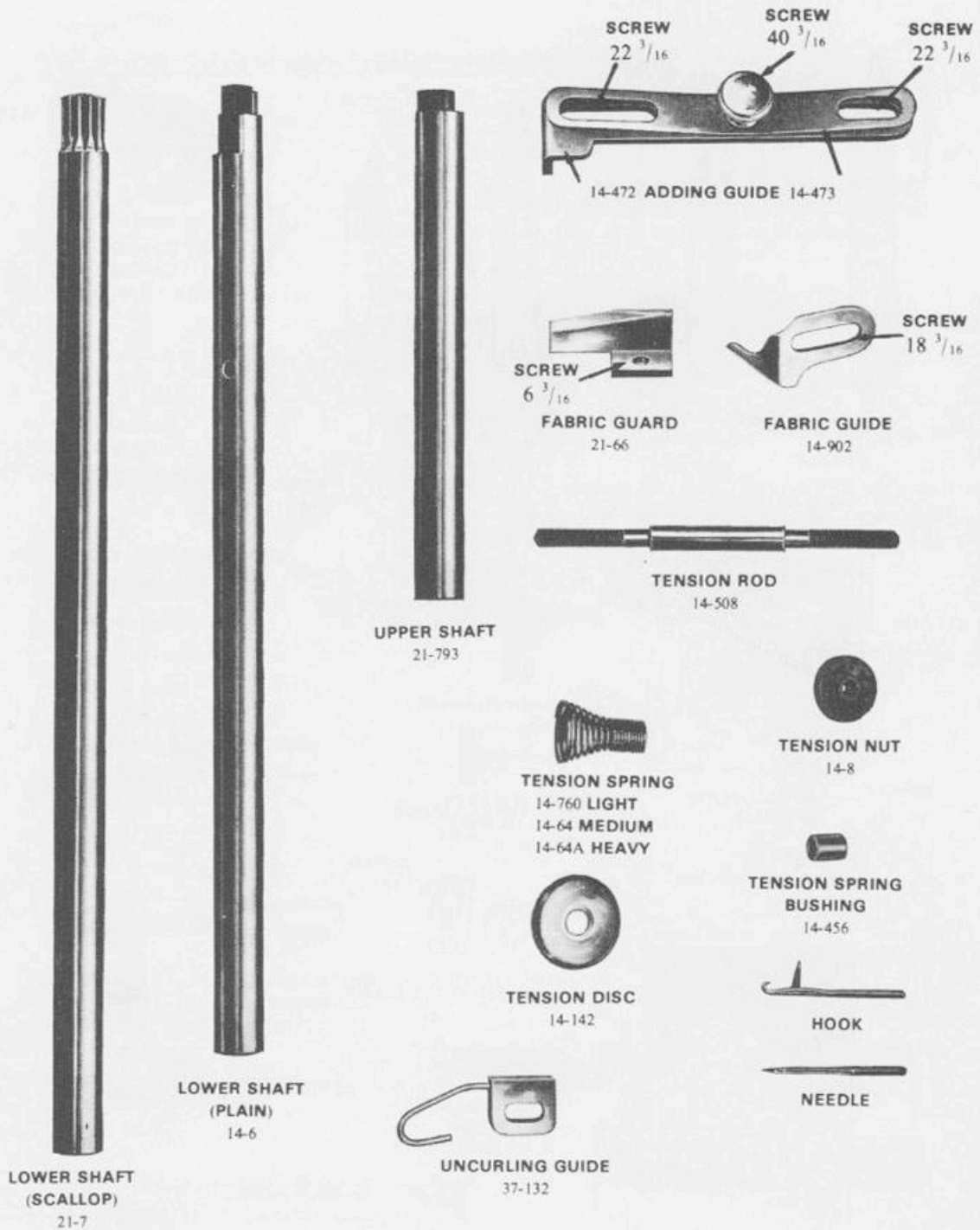

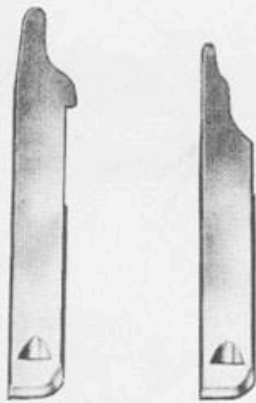

FINGER PLATES
21-32 21-798

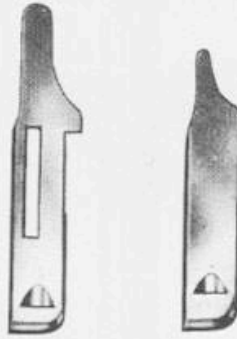

FINGER PLATES
14-85 14-828

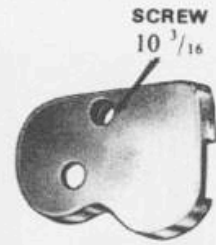

SCREW
 $10 \frac{3}{16}$
STITCH CONTROLLER
CARRIER CAP
14-146



SCREW
 $13 \frac{3}{16}$ SCREW
 $2 \frac{5}{32}$
STITCH CONTROLLER CARRIER
14-90

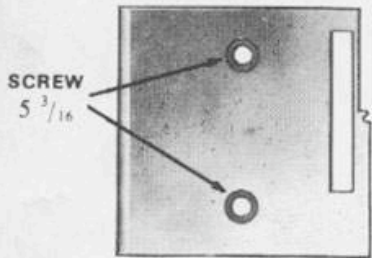

SCREW
 $5 \frac{3}{16}$

NEEDLE PLATE
14-213



STITCH CONTROLLER
CARRIER SPRING



THREAD GUIDE
14-490



STITCH CONTROLLER
14-749

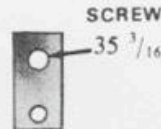

SCREW
 $35 \frac{3}{16}$

FINGER PLATE CLAMP
14-82

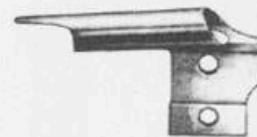

HEMMER
14-465-E

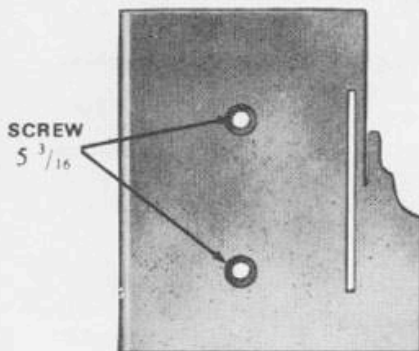

SCREW
 $5 \frac{3}{16}$

NEEDLE PLATE WITH FINGER



HOOK GAUGE
14-739
(Specify Size)



TWEEZERS
37-225-B

ROCKER SHAFT ASSEMBLY
 14-A-2 COMPLETE INCLUDES:
 ROCKER SHAFT 14-854
 ROCKER SHAFT CAP 14-855
 SCREW $7 \frac{3}{16}$

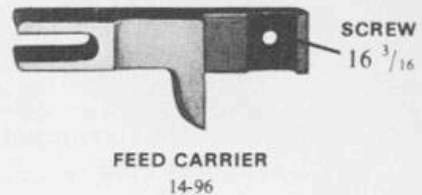
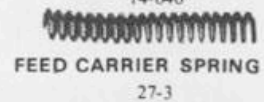
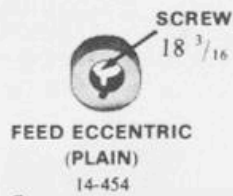
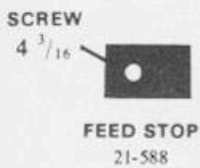
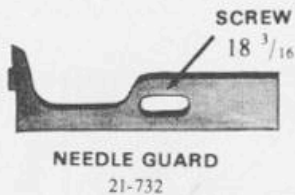
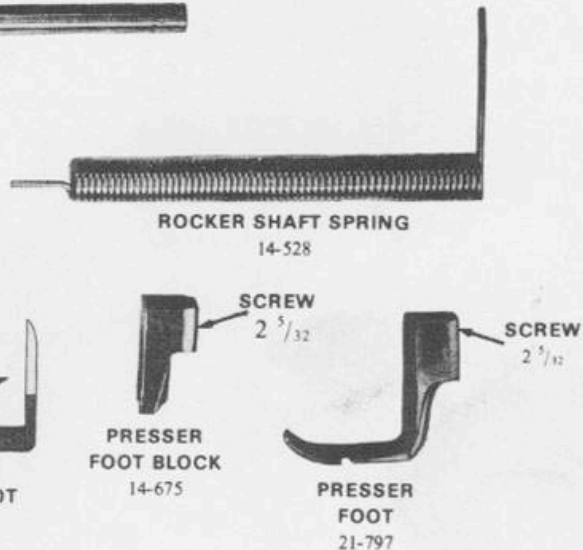
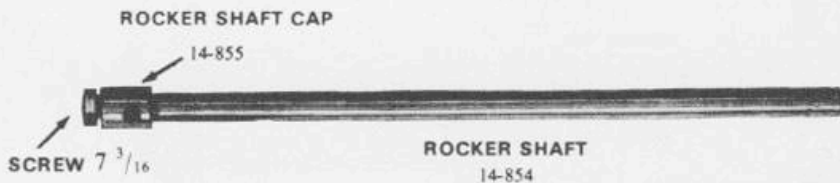

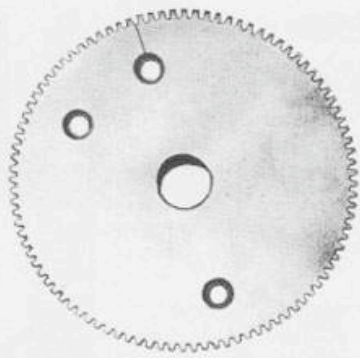

FEED GEAR
21-699

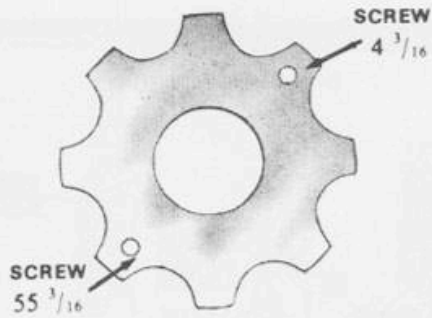

FEED RAISING CAM FOR PLAIN STITCH
21-189



FEED LEVER
21-16-A



FEED RAISING LEVER
21-580



FEED RAISING LEVER STUD
17 1/4



FEED RAISING LEVER PIN
21-577



FEED COVER FASTENER SCREW
21-511



FEED LEVER CONNECTION
21-53



FEED LEVER STUD
21-14

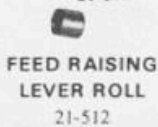

FEED RAISING LEVER ROLL
21-512

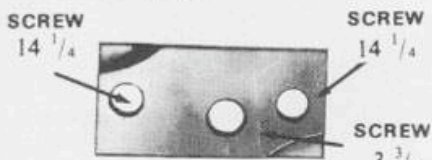

GEAR STUD SUPPORT
21-806



FEED ECCENTRIC (SCALLOP)
21-248

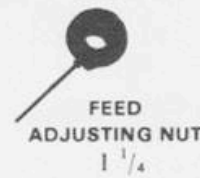

FEED ADJUSTING NUT
1 1/4



FEED ADJUSTING BOLT
21-478



FEED GEAR STUD
3 3/8

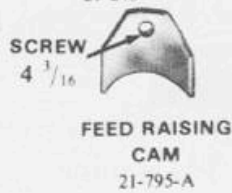

FEED RAISING CAM
21-795-A



FEED AND NEEDLE NUT WRENCH
30-1

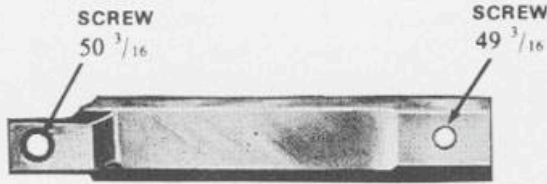

FEED RAISING LEVER SLIDE

21-809

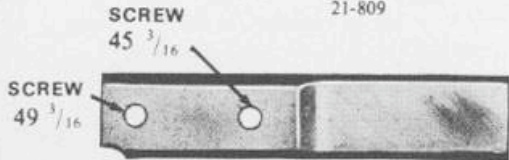

FABRIC GUIDE SLIDE

21-808



STITCH CHANGING LEVER LINK

21-871-A

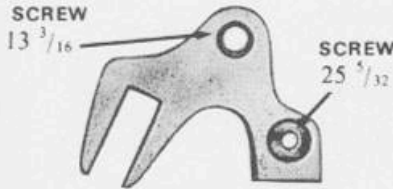

CAST OFF CARRIER

21-790



FEED RAISING LEVER SLIDE BUSHING

21-823

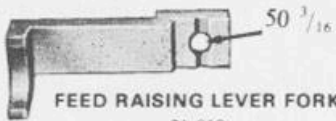

FEED RAISING LEVER FORK

21-819



STITCH CHANGING LEVER LINK BUSHING

21-818



CAST-OFF HORN

21-788 SERIES



THUMB KNOB

21-813



LINK SCREW FOR TAKE-UP

44 3/16



CAST-OFF HORN CARRIER BLOCK

21-791



CAST-OFF HORN CLAMP

21-789



THREAD GUIDE

21-777

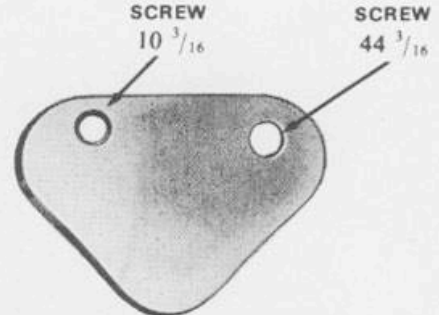

CAST-OFF CARRIER CAP

21-792

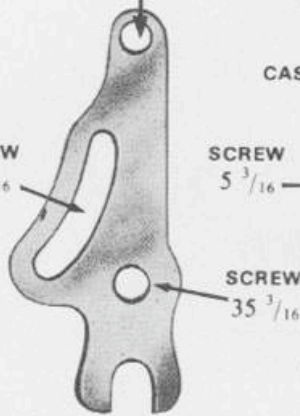

STITCH CHANGING LEVER

21-812-A

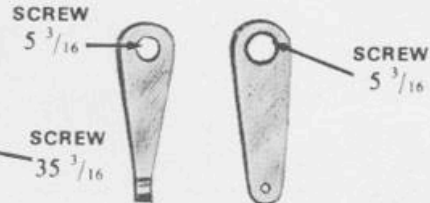

ADJUSTABLE THREAD GUIDES

21-779

21-778



FABRIC GUARD

21-763-B



STITCH CHANGING LEVER BUSHING

21-814



STITCH CHANGING LEVER LINK BUSHING

21-817



STITCH CHANGING LEVER NUT

21-815

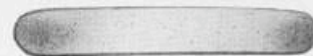

FABRIC GUIDE SLIDE SPRING

21-822

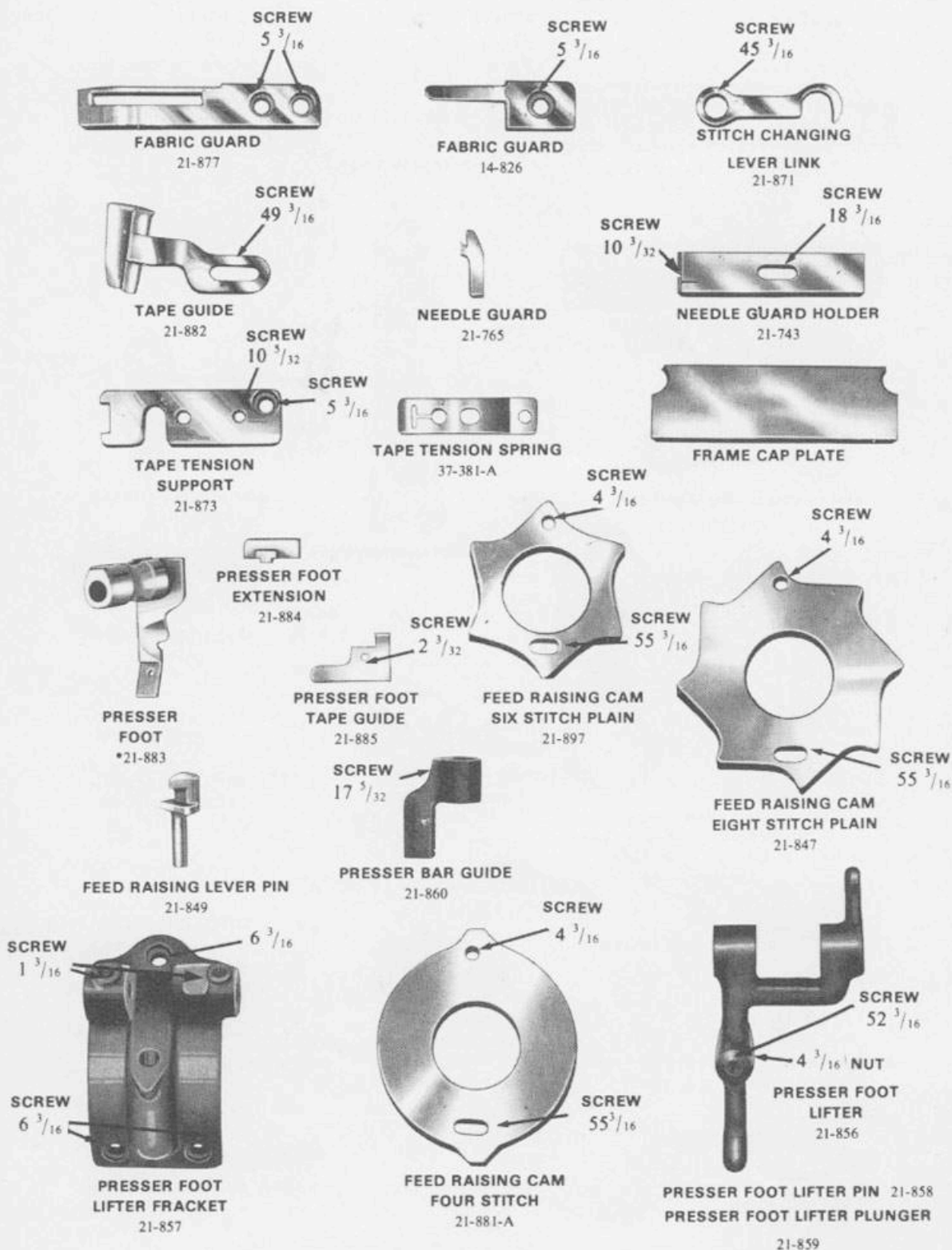

*PRESSER FOOT 21-883 WITH 21-884 USE PRESSER FOOT 21-949
 PRESSER FOOT 21-883 WITH 21-884-A USE PRESSER FOOT 21-952

Index

	<i>Section</i>
Adding Attachment	21
Adjustable Thread Guides	23, 24
Alphabetical Index	Pages 21 thru 26
Cast Off Horn (Moving)	25
Cast Off Horn (Stationary)	26
Eight Stitch Shell	30
Eight Stitch Shell and Plain Crochet	35
Fabric Edge Guide	42
Fabric Guard	29
Feed Gear and Feed Raising Cam Combinations	Page 28
Feed Raising Cam for Plain Stitch	34
Feed (Plain Crochet)	17
Feed (Shell Stitch)	18
Finger Plate	16
Four Stitch Shell	31
Four and Eight Stitch Shell	32, 33
Hook	Page 26 & Section 14
Hook and Needle Combinations	Page 27
Hook Carrier	15
Hook Carrier Guide	15
How to Order	Page 1
Latch Needle	14
Lubrication	10
Needle	Page 27 & Section 12
Needle Guard	13
Needle Thread Takeup	23
Parts Illustrated	Pages 29 thru 36
Plain Crochet Stitch	34, 35, 39
Setting Up	Page 6
Six Stitch Shell	36
Six Stitch Shell and Plain Crochet	39
Special Feed Gears	40
Speed	9
Stitch Changing	41
Stitch Controller	20
Supplemental Thread Carrier	19
Takeup	23, 24
Taping	Page 20 & Section 43
Tension	27
Threading	Pages 18, 19 & Section 22
Thread Stop	28
Three Stitch Shell	37
Three and Six Stitch Shell	38



THE
MERROW[®]
MACHINE COMPANY

28 Laurel Street
Hartford, Ct. 06106
Tel. (203) 522-0265